

# ELMO

## CCD COLOR VIDEO CAMERA

### TNC4614DN/TNC4614X INSTRUCTION MANUAL

	<b>CAUTION</b> RISK OF ELECTRIC SHOCK DO NOT OPEN	
CAUTION : TO REDUCE THE RISK OF ELECTRIC SHOCK. DO NOT REMOVE COVER (OR BACK). NO USER SERVICEABLE PARTS INSIDE. REFER SERVICING TO QUALIFIED SERVICE PERSONNEL.		



The lightning flash with arrowhead symbol, within an equilateral triangle, is intended to alert the user to the presence of uninsulated "dangerous voltage" within the product's enclosure that may be of sufficient magnitude to constitute a risk of electric shock to persons.



The exclamation point within an equilateral triangle is intended to alert the user to the presence of important operating and maintenance (servicing) instructions in the literature accompanying the appliance.

#### CAUTION

- Do not use any power supply other than specified.

#### WARNING

TO REDUCE THE RISK OF FIRE OR ELECTRIC SHOCK, DO NOT EXPOSE THIS APPLIANCE TO RAIN OR MOISTURE.

\* The CAUTION label is attached on the bottom of camera.

#### INFORMATION

This equipment has been tested and found to comply with the limits for Class A digital device, pursuant to Part 15 of the FCC Rules. These limits are designed to provide reasonable protection against harmful interference when the equipment is operated in a commercial environment. This equipment generates, use, and can radiate radio frequency energy and, if not installed and used in accordance with the instruction manual, may cause harmful interference to radio communications. Operation of this equipment in a residential area is likely to cause harmful interference in which case the user will be required to correct the interference at his own expense.

**USER-INSTALLER CAUTION:** Your authority to operate this FCC verified equipment could be voided if you make changes or modifications not expressly approved by the party responsible for compliance to Part of the FCC Rules.

# IMPORTANT SAFEGUARDS

- 1. Read Instructions**

All the Safety and operating instructions should be read before the appliance is operated.
- 2. Retain Instructions**

The safety instructions and instruction manual should be retained for future reference.
- 3. Heed Warnings**

All warnings on the appliance and in the instruction manual should be adhered to.
- 4. Follow Instructions**

All operating and use instructions should be followed.
- 5. Cleaning**

Disconnect this video product from the power supply before cleaning.
- 6. Attachments**

Do not use attachments not recommended by the video product manufacturer as they may cause hazards.
- 7. Water and Moisture**

Do not use this video product near water - for example, near a bath tub, wash bowl, kitchen sink, or laundry tub, in a wet basement, or near a swimming pool and the like.
- 8. Accessories**

Do not place this video product on an unstable cart, stand, tripod, bracket, or table. The video product may fall, causing serious injury to a child or adult, and serious damage to the appliance. Use only with stand, tripod, bracket, or table recommended by the manufacturer, or sold with the video product. Any mounting of the appliance should follow the manufacturer's instructions, and should use a mounting accessory recommended by the manufacturer.
- 9. Ventilation**

This video product should never be placed near or over a radiator or heat register. This video product should not be placed in a built-in installation such as a bookcase or rack unless proper ventilation is provided or the manufacturer's instructions have been adhered to.
- 10. Power Sources**

This video product should be operated only from the type of power source indicated on the marking label. If you are not sure of the type of power supply to your location, consult your appliance dealer or local power company.
- 11. Power-Cord Protection**

Power-supply cords should be routed so that they are not likely to be walked on or pinched by items placed upon or against them, paying particular attention to cords at plugs, screws, and the point where they exit from the appliance.
- 12. Lightning**

For added protection for this video product during a lightning storm, or when it is left unattended and unused for long periods of time, unplug it from the wall outlet and disconnect the power supply and cable system. This will prevent damage to the video product due to lightning and power-line surges.
- 13. Overloading**

Do not overload power supply and extension cords, as this can result in a risk of fire or electric shock.
- 14. Object and Liquid Entry**

Never push objects of any kind into this video product through openings as they may touch dangerous voltage points or short-out parts that could result in a fire or electrical shock. Never spill liquid of kind on the video product.
- 15. Servicing**

Do not attempt to service this video product yourself as opening or removing covers may expose you to dangerous voltage or other hazards. Refer all servicing to qualified service personnel.
- 16. Damage Requiring Service**

Disconnect this video product from the power supply and refer servicing to qualified service personnel under the following conditions.

  - a. When the power-supply cord or plug is damaged.
  - b. If liquid has been spilled, or objects have fallen into the video product.
  - c. If the video product has been exposed to rain or water.
  - d. If the video product does not operate normally by following the operating instructions in the instruction manual. Adjust only those controls that are covered by the instruction manual as an improper adjustment of other controls may result in damage and will often require extensive work by a qualified technician to restore the video product to its normal operation.
  - e. If the video product has been dropped or the cabinet has been damaged.
  - f. When the video product exhibits a distinct change in performance - this indicates a need for service.

- 17. Replacement Parts**

When replacement parts are required, be sure the service technician has used replacement parts specified by the manufacturer or that have the same characteristics as the original part. Unauthorized substitutions may result in fire, electric shock or other hazards.
- 18. Safety Check**

Upon completion of any service or repairs to this video product ask the service technician to perform safety checks to determine that the video product is in proper operating condition.

## PART NAMES AND FUNCTIONS

All dimensions in mm (inch)

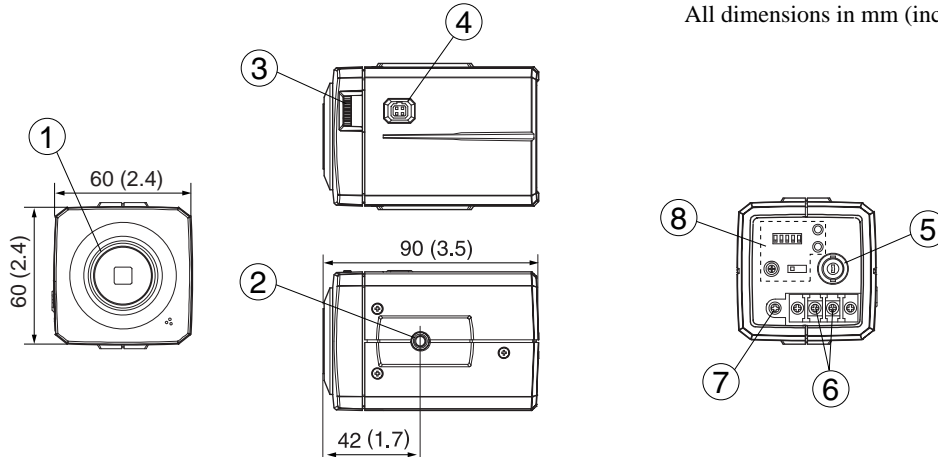

- ① **Lens mount**  
Mount a CS-mount lens.
- ② **Camera mount**  
For mounting a camera on bracket, housing, etc.  
(1/4"-20UNC thread)
- ③ **Focusing dial**  
Refer to "HOW TO USE" on page 3 for adjustment of the lens back-focus.
- ④ **IRIS terminal**  
Connect when an automatic iris lens is used.
- ⑤ **VIDEO OUT terminal**  
Connect to a monitor TV, etc. (BNC connector)
- ⑥ **AC Power terminal**  
Connect this to the AC24V 60HZ or DC12V power supply.

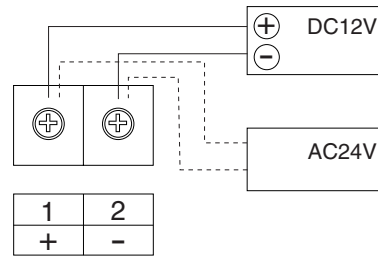

- ⑦ **Ground terminal**  
Connect this to the ground wire of the power supply cord.
- ⑧ **Camera control switches**  
Refer to "CAMERA CONTROLS" on page 4.

## HOW TO CONNECT

Before connection, make sure that power of all units to be connected are OFF and cords are unplugged.

1. Mount a lens onto the camera. Refer to "HOW TO USE" on page 3 for usable lens.
2. Connect video terminal of the camera and the video input terminal of a monitor TV, etc. with a 75Ω coaxial cable.
3. Connect the power terminal of the camera to a power supply.

**Caution:** Installation should be made by a qualified service personnel and should conform to all local codes.

Lens, coaxial cable for video signal and power supply are not supplied with a camera.

# HOW TO USE

- Adjust the iris and focus of the lens so that optimum image may be obtained.

\* Usable lenses

CS-mount lenses, whose length "L" (in the illustration) from the bearing surface of the mount is 4mm or less if protruded, should be used.

Note: Adjustment of the lens back-focus.

The camera is set at the standard back focus position when shipped from factory. Depending on types of zoom lenses, however, slight readjustment may be necessary.

Adjust the lens back-focus by turning the focusing dial in either direction as per the illustration, referring to the following instructions.

- ① Place an object at any fixed distance and set the focus ring of the zoom lens accordingly.
- ② Set the zoom lens to full TELE position and obtain the best focus position by turning the focus ring or the zoom lens.
- ③ Set the zoom lens to full WIDE position and obtain the best focus position by turning the focusing dial located on the side of the camera.
- ④ Repeat procedures ② and ③ until focus remains constant throughout the zooming range.

Note: When weight of the lens is more than 1kg (2.2lbs), the camera should be supported by the lens rather than relying on camera mounting screw.

**Adjust the back-focus only when necessary.**

\* Using an auto iris lens

When a DC driven type auto iris lens is used, set the IRIS switch at DC, and connect the plug of the lens to the IRIS terminal at the side of the camera.

When a video feedback type auto iris lens is used, set the IRIS switch at VIDEO and connect the plug from the lens to the IRIS terminal at the side of the camera. (Refer to the lens manual for the level adjustment.)

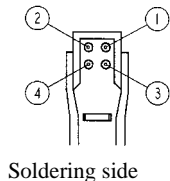
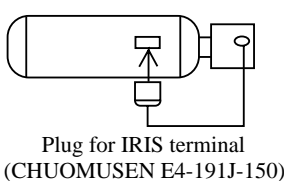

### IRIS terminal

	DC position	VIDEO position
1	Control -	+9V iris power (50mA Max.)
2	Control +	GND
3	Drive +	0.7Vp-p auto iris video signal
4	Drive - (GND)	GND

\* When a video feedback type auto iris lens (peak/average selectable type) is used at peak mode, the BLC feature of the camera may not function correctly. In such a case, change the mode to average

2. Before your use of the camera at AES (Automatic Electronic Shutter) mode.

\* When using an auto iris lens, set the AES switch at OFF. (The AES switch is set at OFF when shipped from factory.)

\* The AES mode may increase smears on monitors, which is caused by characteristics of CCD and that is not a defect of the camera.

\* For C-mount lens, use an optional 5mm ring between the lens and camera.

# CAMERA CONTROLS

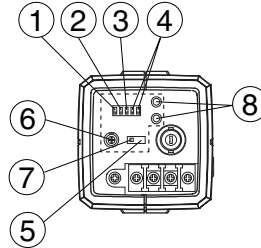

① **DAY/Night switch(Set at OFF position from the factory)**

In OFF position, video will retain color all the time.

In ON position, video will change from color to black & white at very low ambient Light.

② **BLC (Back Light Control) switch(Set at OFF position from the factory)**

In case the back lighting is too bright to shoot the main object clearly, set this switch to ON position.

③ **INT/LL switch(Set at LL position from the factory)**

• **INT. (internal) control switch**

When the internal synchronization is used, set the switch to the INT side.

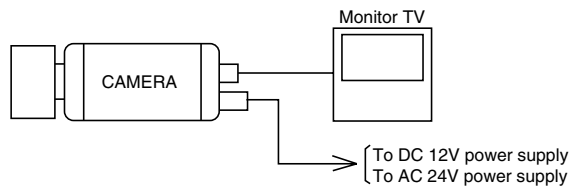

• **L.L. (Line-lock) control switch**

Matching the vertical synchronization with the power frequency is called the Line-Lock.

When two or more cameras are switched by the video switcher to a monitor TV, the vertical

sync. phase can be locked with the power frequency, and a stable vertical sync. is obtained without being disturbed at the time of switching. Line-Lock is operative only when the AC 24V power supply is connected.

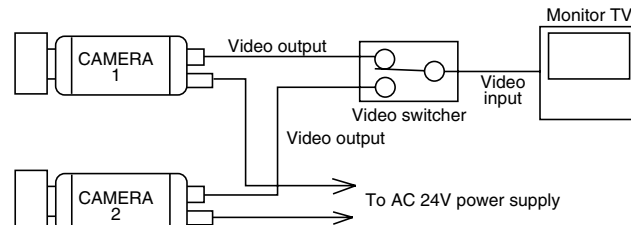

**Caution:**

1. The camera is synchronized to the power frequency of 60Hz  $\pm$  0.5Hz covering a normal fluctuation of the power frequency.

The camera may not compensate for large fluctuation caused by power generated by an engine generator, etc.

2. It takes about 10 seconds or more to obtain a stable synchronization after the power is turned on. This is necessary to stabilize the camera against the power noise.

3. When DC 12V power supply is used, set the switch to the INT side.

④ **White balance selector**

Manual or Automatic white balance modes are selectable. With the setting at AUTO position, the camera automatically adjusts to the color temperature and adjusts the white balance. The camera is factory-set at AUTO position. For manual adjustment, set to MANU position and set the white balance switches as follows.

White balance (WB): According to the combination of the switches 1 and 2, the following adjustments are available:

WB1	WB2	
L	L	ATW
L	H	* Manual (Shift change)
H	L	Manual (Fixed 3200K)
H	H	Manual (Fixed 4200K)

\*: Can be adjusted by the PUSH switch.

⑤ **IRIS switch**

When a DC driven type auto iris lens is used, set this switch to DC position. When a video feedback type auto iris lens is used, set this switch to VIDEO position.

⑥ **ALC LEVEL**

Adjust video output level, when IRIS switch is DC position.

⑦ **AES switch (Automatic Electronic Shutter)**

By setting the AES switch, Automatic Electronic Shutter mode (1/60~1/100,000 sec) is available.  
Note: In electronic shutter mode;

\*Sufficient brightness is required.

\*The picture will flicker when shooting under the illumination produced by fluorescent lamp.

⑧ **PUSH button**

• **Vertical sync. phase adjustment**

Vertical sync. phase adjusting is set at the position fully that the delay time of vertical sync. phase against the phase of power frequency is shortest, when shipped from the factory.

Select this ⑧ up (▲) and down (▼) button will make the delay time of vertical sync. phase against the phase of power frequency longer.

Use the push button ⑧ if the picture image on a monitor TV may flow when using the camera in combination with other camera(s) controlled by the Line-Lock synchronization.

In this case, get a proper image by shifting the phase of vertical sync. signal of the camera against that of the other. If a proper image cannot be obtained even after this adjustment, reset the potentiometer to its original position, and use the function control potentiometer ⑧ of the other camera to shift the phase of vertical sync. signal of other camera.

Caution: Before making adjustment, make sure that cameras have their power supplies connected with the same polarity. (not 180° apart)

• **Manual white balance selector**

When the white balance selector is set to MANU (shift change) in 4 above, the white balance can be adjusted by using the PUSH switch. This mode will prove effective under shooting conditions with little variation in color temperature.

\*When the white balance selector is set to MANU (shift change), the vertical sync. phase can not be adjusted.

## SPECIFICATIONS

Model	TNC4614DN / TNC4614X	
Power source	DC12V (DC11V-35V)	AC24V (AC15V-27V) 60Hz ± 0.5Hz
Power consumption	Approx.4.5W	Approx.4.0W
Pick-up device	1/3"Color interline-transfer CCD	
Effective picture element	768 (H) x 494 (V)	
Scanning area	4.9mm (H) x 3.7mm (V)	
Scanning system	2:1 interlaced	
Scanning frequency	Int : 15.734kHz, 59.94Hz / LL : 15.75kHz, 60Hz	
Sync. system	Internal	Line-lock/Internal
Resolution	480 TV lines (H) 350 TV lines (V)	
Recommended illumination	50 lx (F1.2 under incandescent lamp)	
AGC	Built-in	
Day/night	Built-in (Factory-set at OFF)	
White balance	ATW/MNL/Preset (Factory-set at ATW)	
Backlight control	Built-in (Factory-set at OFF)	
AES (Automatic Electronic Shutter)	Built-in (Factory-set at OFF) 1/60~1/100,000 sec.	
Output signal	VBS 1.0 Vp-p, 75Ω, NTSC, compatible	
Auto-iris terminal	4P (DC/Video)	
Power terminal	2P terminal strip	
Lens mount	CS	
Ambient temperature	-10°C ~ +50°C (14°F~122°F)	
Ambient humidity	30% ~ 90%	
Dimensions	60 (W) x 60 (H) x 90 (D)mm (2.4 x 2.4 x 3.5 inches)	
Weight	300grm (0.7lbs)	

Note: Weight and dimensions are approximate.

Design and specifications are subject to change without prior notice.

## PRECAUTIONS FOR USE AND INSTALLATION

- \* Never aim the camera at the sun.  
Never aim or point the camera at the sun even if you are not shooting.
- \* Do not shoot intense light.  
Strong light such as a spot light on the image plane will cause blooming or smear. When strong light comes into the image plane, vertical stripes may appear on it. However, this does not mean that the camera is defect.
- \* Take precautions when handling a camera.  
Do not drop your camera, or give it a strong shock or vibration. This may cause camera to malfunction.
- \* Do not touch internal parts.  
Be sure not to touch the internal parts. This may cause to electrical shock.
- \* Do not let the camera get wet.  
Install the camera at the place where it will not get wet.  
Should it gets wet, turn off the power immediately and contact your dealer.
- \* Install your camera where no video noise appears.  
When camera cables have been laid near electric wires or television receivers, a noise may interfere the image.  
If noise occurs, relocate cables or reinstall equipment.
- \* Check the ambient temperature and humidity.  
Avoid using camera in areas where temperature is consistently hotter or colder than the specified range (See Specifications chart below) or poor image quality or damaged parts may occur. Precautions should also be taken to avoid areas of high humidity.
- \* Should you notice any trouble.  
If any trouble occurs while you are using the camera, turn off the camera and contact your dealer. Failure to do so may cause damage to the camera.
- \* The socket-outlet should be installed near the equipment and should be easily accessible.

**ELMO** and **ELMO** are registered trademarks of ELMO COMPANY, LIMITED.

**ELMO**® **ELMO CO., LTD.** 6-14, Meizen-cho, Mizuho-ku,  
Nagoya, 467-8567 Japan

### OVERSEAS SUBSIDIARY COMPANIES

#### **ELMO Mfg. Corp.**

1478 Old Country Road,  
Plainview, NY 11803-5034  
U.S.A.  
Tel. 516-501-1400  
Fax. 516-501-0429  
E-mail:elmo@elmousa.com  
Web:http://www.elmousa.com

6X1NHFF02

#### **ELMO Canada Mfg. Corp.**

44 West Drive, Brampton,  
Ontario, L6T 3T6,  
Canada  
Tel. 905-453-7880  
Fax. 905-453-2391  
E-mail:info@elmocanada.com  
Web:http://www.elmocanada.com/

#### **ELMO (Europe) G.m.b.H.**

Neanderstr. 18  
40233 Dusseldorf,  
Germany  
Tel. 0211-376051-53  
Fax. 0211-376630  
E-mail:elmoeurope@AOL.com  
Web:http://www.elmo.de/

Printed in CHINA